

Varenummer: 2031120M30150B2T
 Beskrivelse: E+G Justerfod
 GN 31-120-M30-150-B2-T
 Note: T Uden møtrik, spændeflade i bunden

Mål

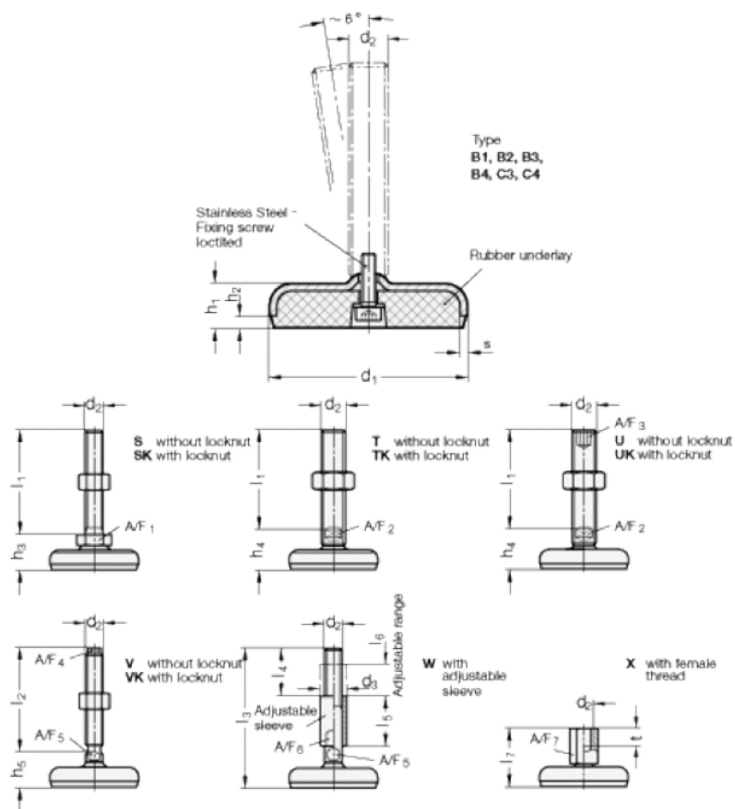

A/F2	= 24
d1	= 120
d2	= 30
h1	= 22
h2	= 6
h4 +4.0/0	= 46
l1	= 150
s	= 4